

# Data Sheet



Article number: 588N3B616ST0471

Description: Solenoid valve type N3B616.ST0.471 3/2 NC  
24 VDC orifice 1,6 housing in Stainless AISI 303 Inlet port G1/8"

## Measures

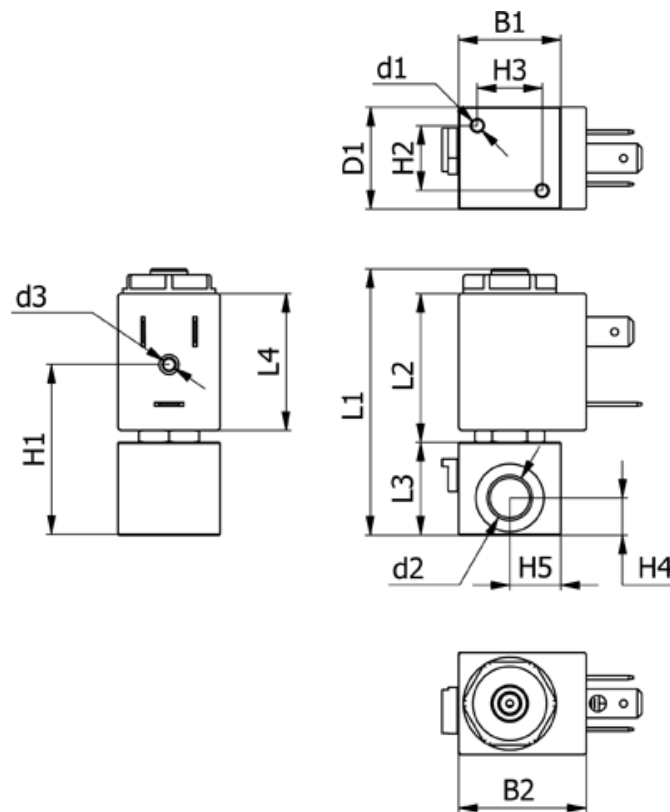

B1 = 22	H2 = 14	Orifice = 1.6
B2 = 31.1	H3 = 14	Valve function = 3/2 NC
d1 = M3x6	H4 = 8	Voltage = 24 VDC
D1 = 22	H5 = 11	
d2 = G1/8"	L1 = 56.2	
d3 = M3x4	L2 = 32.1	
Flow = 1.1	L3 = 20	
H1 = 36.6	L4 = 29.5	